

SPECIFICATIONS

Magnum XXL® 8 Inch Air-Cooled Reflector Generation 3

Item #904515



• = yes

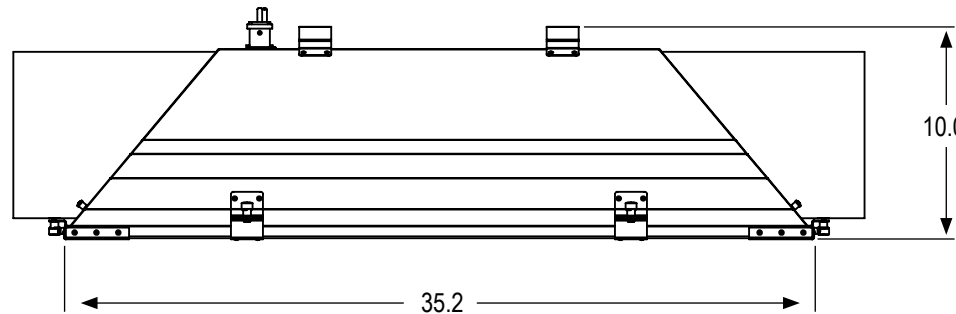
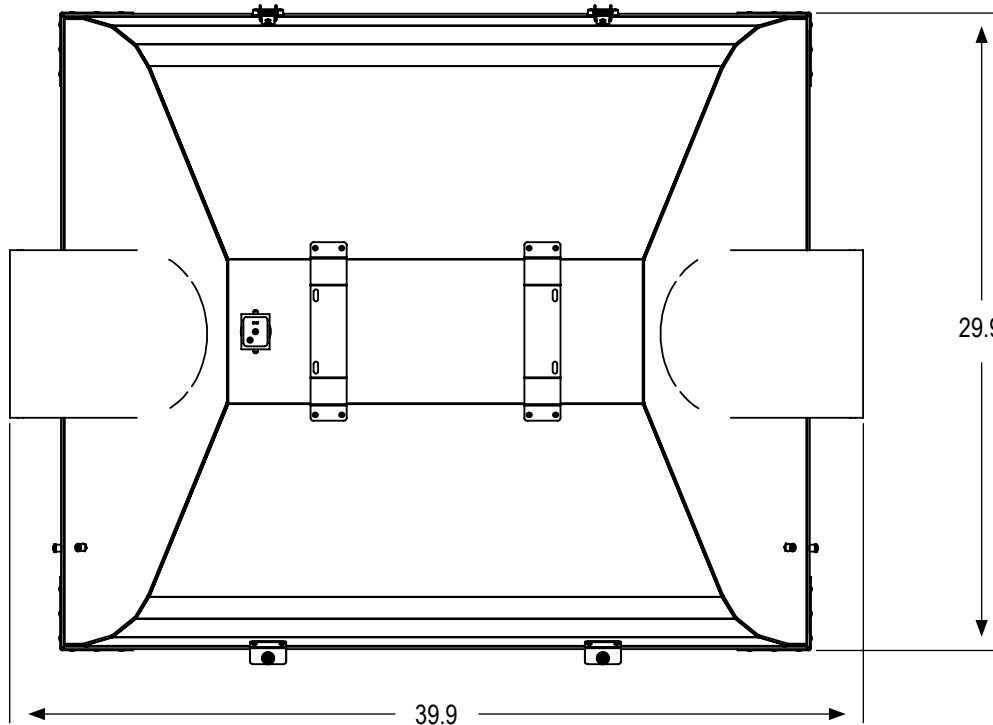

REFLECTOR WEIGHT: 30.4 lbs

•	ETL LISTED
	NOT ETL LISTED
Tested to UL Standard #1598	
•	AIR-COOLED
•	ACCEPTS GLASS
•	HINGED GLASS FRAME
•	DETACHABLE LAMP CORD
•	600 VOLT RATED CORD
•	FABRICATED IN USA*
•	5 YEAR WARRANTY
BALLAST COMPATIBILITY	
•	HPS
•	MH
Max. Wattage: 1500	
LAMP COMPATIBILITY	
•	HPS
•	MH
Max. Wattage: 1500	
LAMP POSITION	
•	HORIZONTAL
	VERTICAL
LAMP SOCKET TYPE	
	INTEGRATED DOUBLE-ENDED
•	INTEGRATED 5KV MOGUL BASE

* with US and globally sourced parts



This document is not intended to be used for installation purposes. We cannot cover all specific applications or anticipate all requirements. All specifications are subject to change without notice.