

**Register your product
to activate warranty**

www.phytolite.com

**GX PROFESSIONAL LINE
NX2 ENTRY LINE**

WARNING

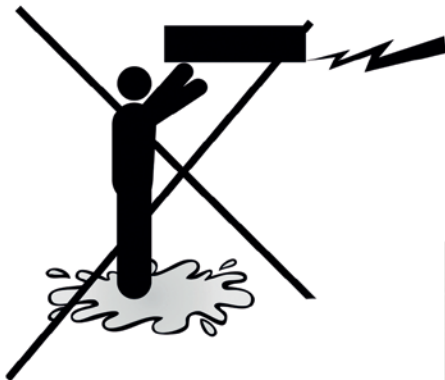

NO!

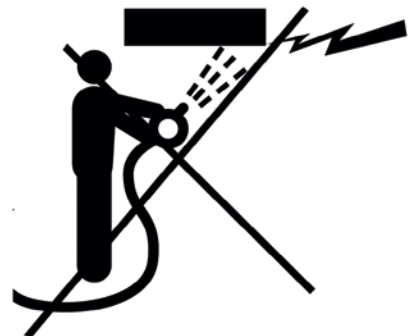

CE



	A. ELECTRIC CABLE 220V	B. EXTRA LENSES 120°	C. SECONDARY ELECTRIC CABLE PLUG	D. GX/NX2 HANGING SET
GX LINE	<input checked="" type="checkbox"/>	<input checked="" type="checkbox"/>	<input checked="" type="checkbox"/>	<input checked="" type="checkbox"/>
NX2 LINE	<input checked="" type="checkbox"/>	<input type="checkbox"/> OPTION	<input type="checkbox"/> OPTION	<input checked="" type="checkbox"/>

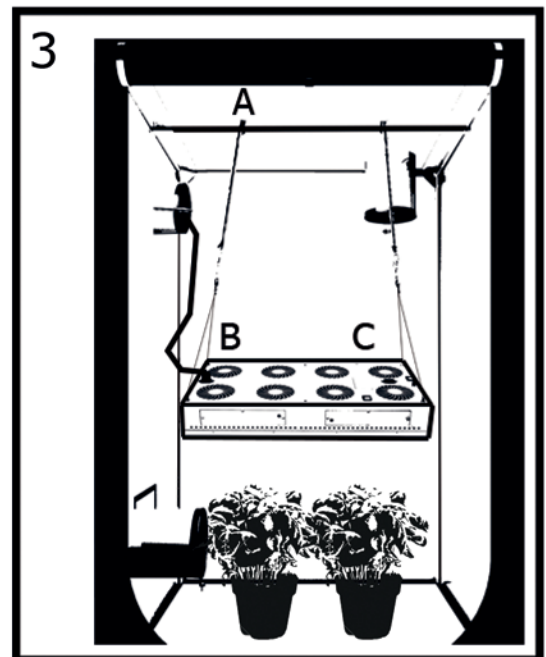
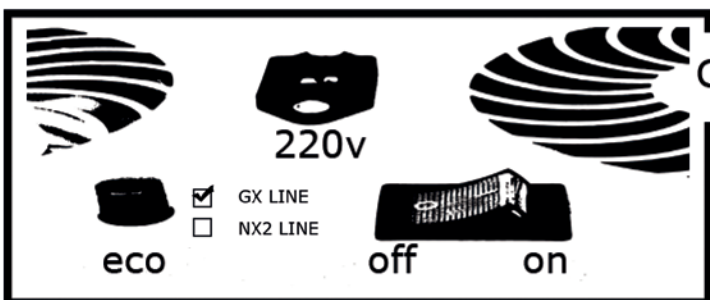
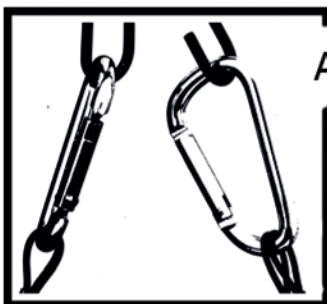
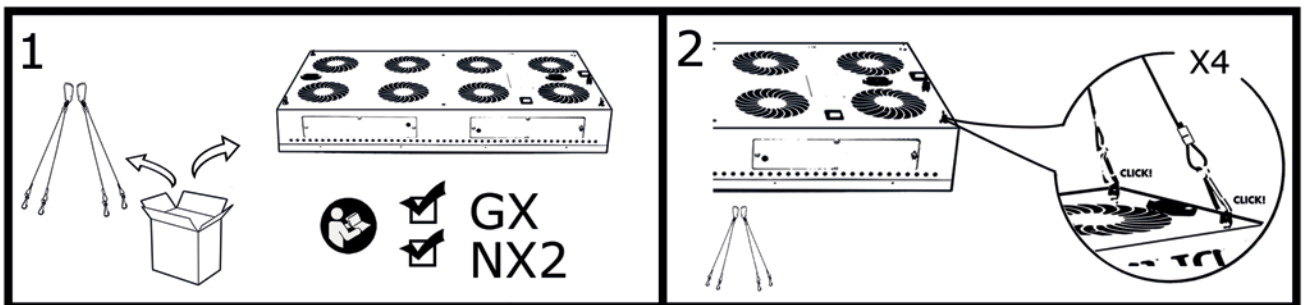

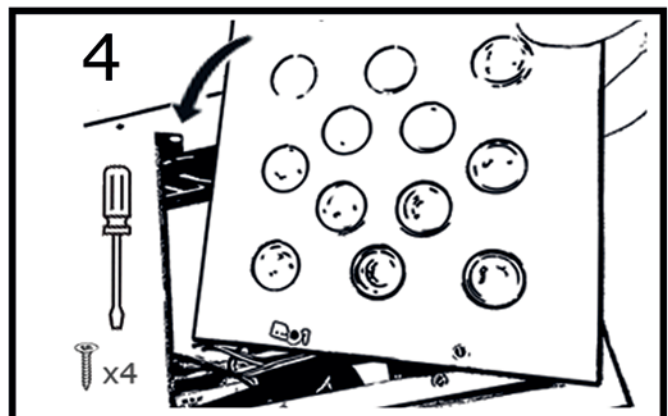
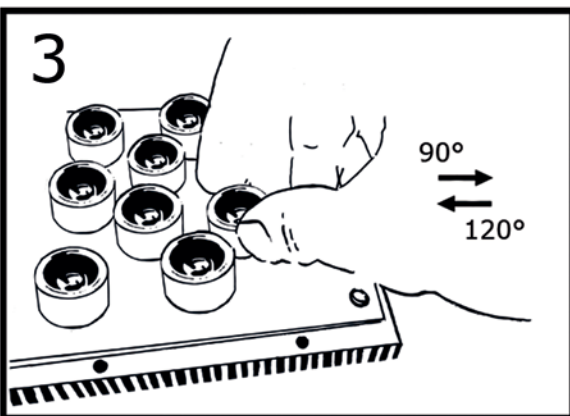
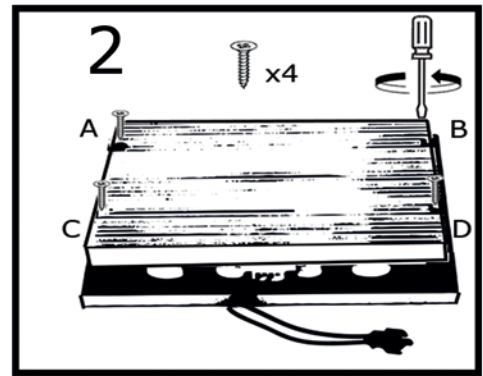
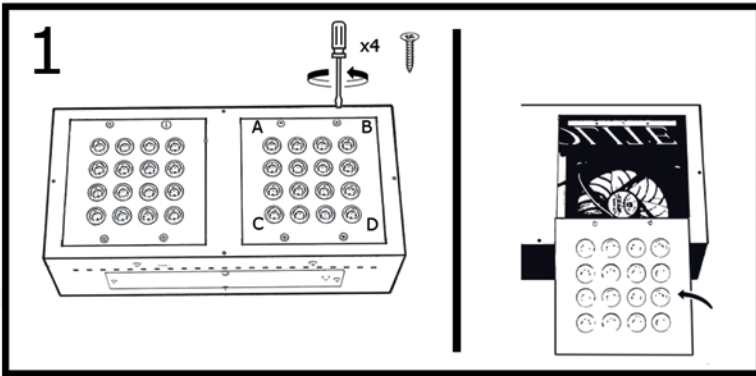
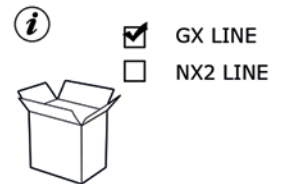
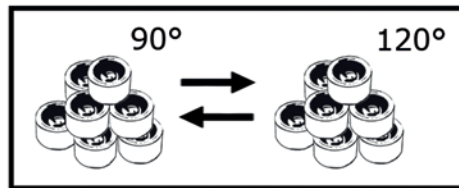
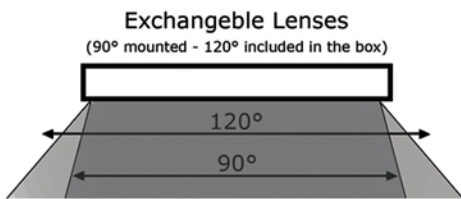
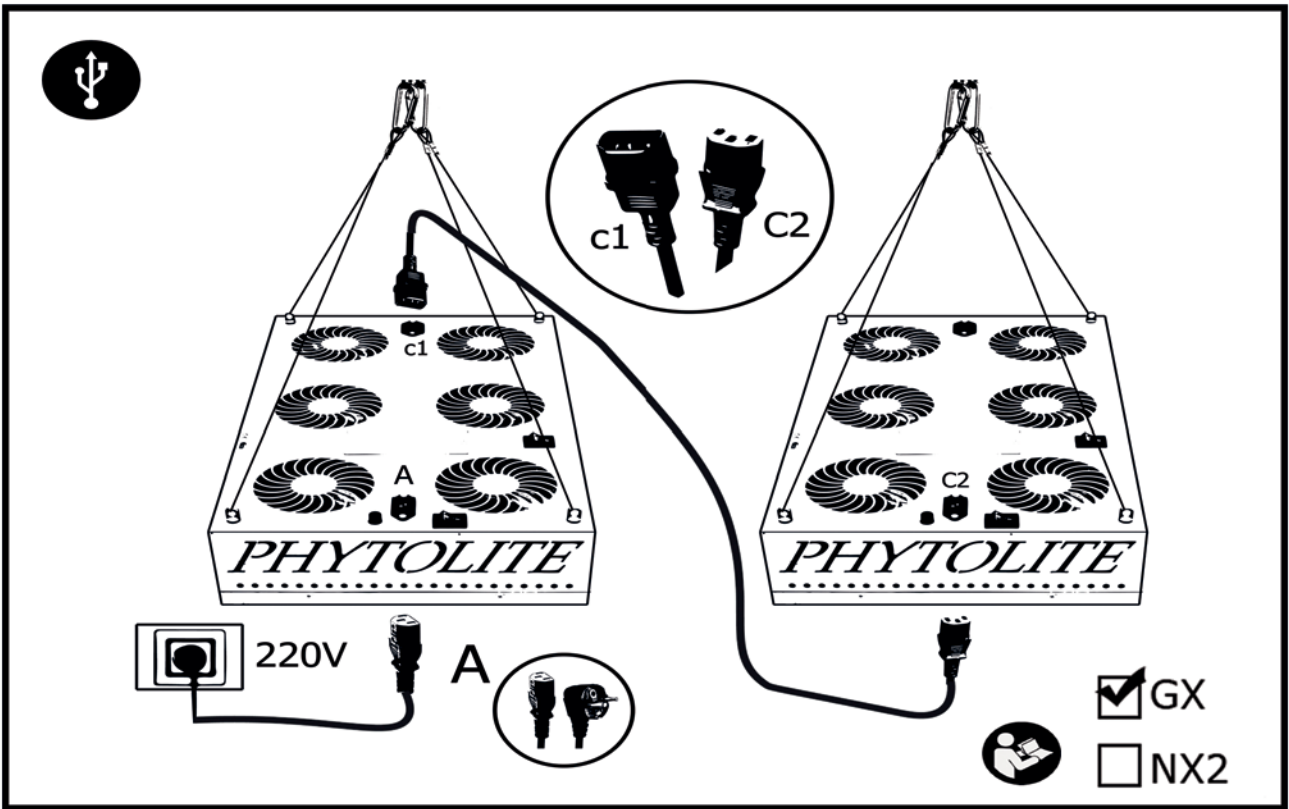

OPTION

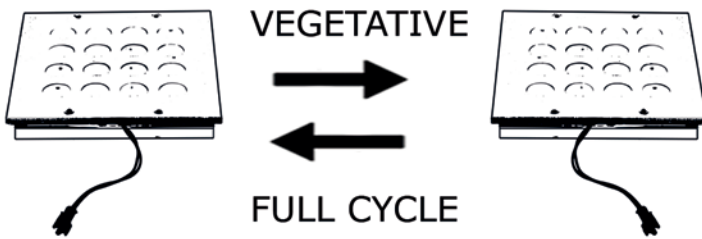

GX LINE



NX2 LINE

