

# DARK BOX TOWER

DBT120: 120x120x235cm  
DBT145: 145x145x235cm  
DBT240W: 240x120x235cm  
DBT200: 200x200x235cm  
DBT290: 290x290x235cm

## Instructions

- Step1. Assemble metal poles & all corners as metal frame diagrams shown in page-2. **To avoid tent cover's damage, it is very important that you check all the poles are pushed fully into each corner joiner.**
- Step2. Un-zip the zipper system all the way, but leave the zippered side windows or back doors closed.
- Step3. To wear tent cover onto the metal frame more easily. You may lie the metal frame 90 degree down. Start with tent's roof. **(for 240x120x235cm, 200x200x235cm, and 290x290x235cm, you can start with tent's base.)** Snugly and carefully fit tent cover onto four corners of top frame like pic A.
- Step4. Put the base of tent cover beneath metal frame. Make sure four sides of tent's floor locate snugly as pic B.
- Step5. Close the zipper system up carefully. You may have to push upright poles a little to cross the corners over as pic C.
- Step6. Attach water-proof tray with its Velcros onto the metal poles, hang shallow/ deep bars on, use Nylon fabric straps to hang reflectors or carbon filters. Done!



pic A



pic B



pic C

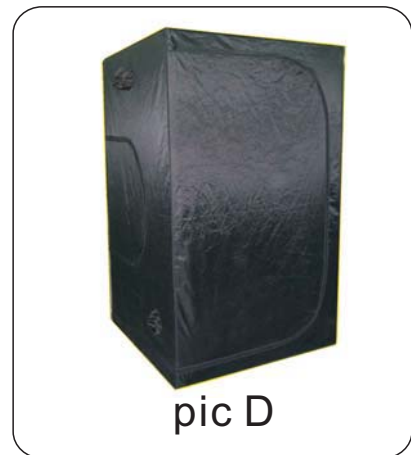

pic D

\*When disassembling Dark Box Tower grow tent, do it reversely as above instruction steps and always be with care to ensure its light proof performance next time when you use it to grow!\*



X8



X4

DBT120  
&  
DBT145

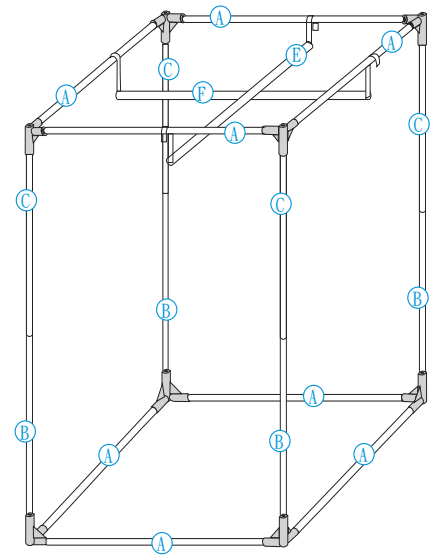
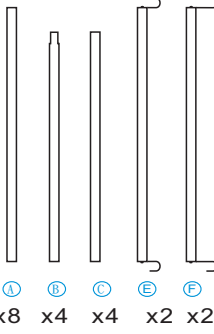

DBT240W

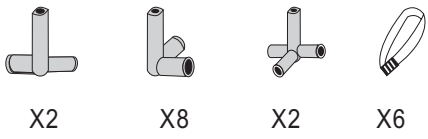

X2

X8

X2

X6

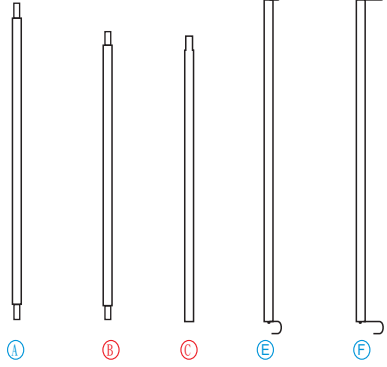

x13

x6

x6

x4

x4

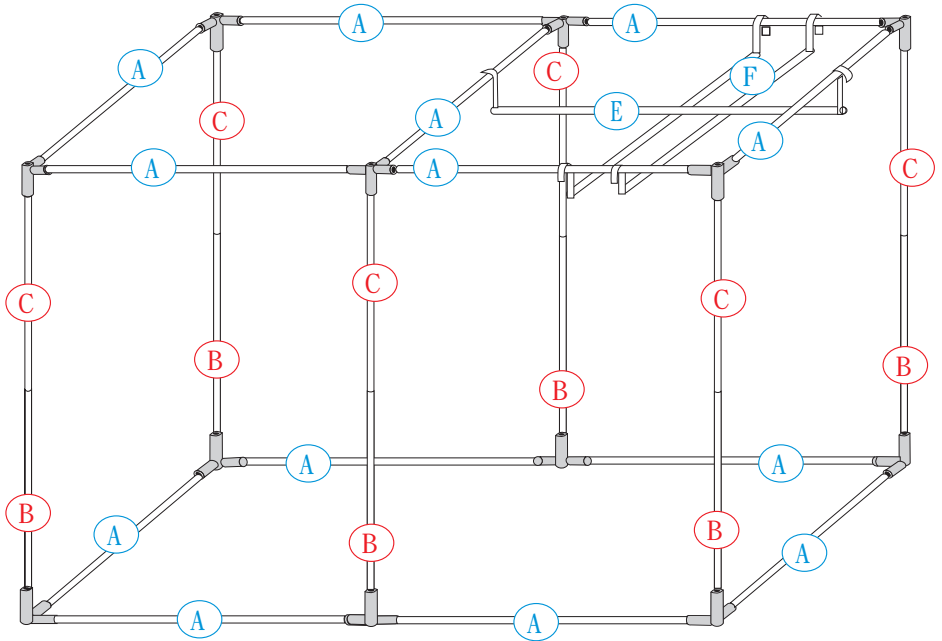

DBT200  
&  
DBT290

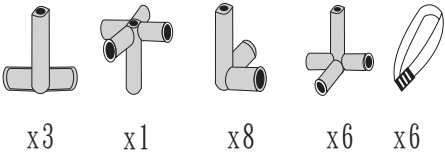

x3

x1

x8

x6

x6

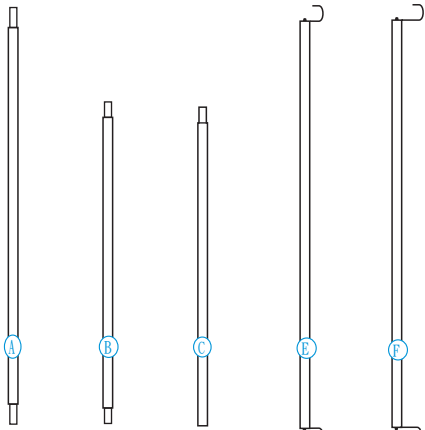

x22

x9

x9

x4/8

x8

